

# Hyperbolic 2-fold Branched Coverings

MATTIA MECCHIA (\*)

*Dedicated to the memory of Marco Reni  
with deep gratitude for his patient and careful teaching.*

SUMMARY. - *In the Kirby list is presented the following problem: describe the equivalence classes in the set of knots under the relation  $K_1$  is equivalent to  $K_2$  if their 2-fold cyclic branched coverings are homeomorphic 3-manifolds. In this paper we consider the basic case of hyperbolic manifold. In the first part of this paper we want to present briefly the results, yet available in some previous works, which solve this problem. In the second part we present examples of knots with the same 2-fold branched covering which show that the theorem, which describes the possible relations between two knots in the same equivalence class, is the best possible.*

## 1. Introduction

The 2-fold branched coverings of knots in the 3-sphere are a basic class of 3-manifolds largely studied in low dimensional topology. Such a representation of a 3-manifold is, in general, not unique. In the Kirby list ([5]) is presented the following problem: describe the equivalence classes in the set of knots under the relation  $K_1$  is equiva-

---

(\*) Author's address: Università degli Studi di Padova, Dipartimento di Matematica Pura ed Applicata, Via Belzoni,7 - 35131 Padova, Italy, e-mail: mmecchia@math.unipd.it

Keywords and phrases: cyclic branched covering, hyperbolic knot, hyperbolic 3-manifold.

1991 Mathematics Subject Classification: 57M12; 57M25; 57M50.

lent to  $K_2$  if their 2-fold cyclic branched coverings are homeomorphic 3-manifolds.

We consider separately two aspects of the problem in the Kirby list.

PROBLEM 1.1: How many inequivalent knots can have the same 2-fold branched covering  $M$ ?

PROBLEM 1.2: How are related two inequivalent knots with the same 2-fold branched covering  $M$ ?

In this paper we consider the basic case of hyperbolic manifolds. The solutions of these problems when  $M$  is hyperbolic are presented in some previous papers by Marco Reni and by the author; in the first part of this paper we want to present briefly these results with the aim of giving a complete description of the situation.

Moreover the solution of these two problems in the hyperbolic case is strictly related via Thurston's orbifold geometrization theorem to the structure of the orientation-preserving isometry group  $G$  of  $M$ , and in particular to the structure of any Sylow 2-subgroups of  $G$  (for Thurston's theorem see [16], [1] and [3]). Thus the results presented in this paper are also interesting because they give a description of Sylow 2-subgroups when  $M$  is the 2-fold branched covering of a knot in the 3-sphere or more general when  $M$  is a  $\mathbb{Z}_2$ -homology sphere. We consider both the algebraic structure of the Sylow 2-subgroup of  $G$  and their "geometric" structure that is the reciprocal positions of the fixed-point sets of the elements.

In the second part of the paper we construct examples of inequivalent knots in the 3-sphere with the same 2-fold branched covering which show that the description, we give in Theorem 2.5, of the possible relations between two knots with the same 2-fold branched covering, is the best possible.

## 2. Solution of the Problems 1.1 and 1.2

First I want to recall some preliminary facts about 3-manifold that describe the relation between 2-fold cyclic branched covering and  $\mathbb{Z}_2$ -homology 3-sphere.

- The 2-fold branched covering of a knot in the 3-sphere is a  $\mathbb{Z}_2$ -homology sphere ([7, pag. 16]).

- The quotient of a  $\mathbb{Z}_2$ -homology sphere by an involution with non-empty fixed-point set is a  $\mathbb{Z}_2$ -homology 3-sphere.

The algebraic structure of the Sylow 2-subgroups of the orientation-preserving isometry group of a  $\mathbb{Z}_2$ -homology 3-sphere was described by Marco Reni [12] who proved the following theorem:

**THEOREM 2.1.** [12] *Let  $M$  be a closed orientable  $\mathbb{Z}_2$ -homology 3-sphere and  $S$  a finite 2-group of orientation-preserving diffeomorphisms of  $M$ . Then one of the following case occurs:*

-  $S$  is cyclic, dihedral of order at least 16, quasidihedral or a quaternion group and the unique central involution acts freely;

-  $S$  contains with index at most two the centralizer  $C_{Sh}$  of an involution  $h$  with connected fixed-point set. The group  $C_{Sh}$  is a subgroup of a semidirect product  $\mathbb{Z}_2(\mathbb{Z}_{2^a} \times \mathbb{Z}_{2^b})$ , for some nonnegative integers  $a$  and  $b$ , where  $\mathbb{Z}_2$  acts on  $\mathbb{Z}_{2^a} \times \mathbb{Z}_{2^b}$  inverting each element.

If  $M$  is hyperbolic, the orientation-preserving isometry group  $G$  of  $M$  is finite and Theorem 2.1 applies to the Sylow 2-subgroups of  $G$ ; thus it is possible to prove the following theorem.

**THEOREM 2.2.** [12] *There are at most nine conjugacy classes of non-free involutions in the orientation-preserving isometry group of a closed orientable hyperbolic  $\mathbb{Z}_2$ -homology 3-sphere.*

By Thurston’s orbifold geometrization theorem and Mostow’s rigidity Theorem we obtain as a consequence of Theorem 2.2 the following corollary that gives an upper bound to the number of inequivalent knots with the same hyperbolic 2-fold cyclic branched covering.

**COROLLARY 2.3.** [12] *For a hyperbolic manifold  $M$ , there are at most nine inequivalent knots with  $M$  as cyclic branched covering.*

Here two knots  $K$  and  $K'$  are inequivalent if there is no orientation-preserving diffeomorphism of the 3-sphere which maps  $K$  to  $K'$ .

Corollary 2.3 gives an universal bound which holds for all hyperbolic manifolds and we have an answer to the Problem 1.1. The natural question which arises is if this bound is the best possible; sets of four such knots are known, and there is some evidence that nine may be the exact upper bound.

In [12], Theorem 2.1, Theorem 2.2 and Corollary 2.3 are proved applying methods of finite group theory to the study of these manifolds and we obtain an algebraic description of the Sylow 2-subgroup. Now we can start from this algebraic description to obtain geometric information about Sylow 2-subgroup (for example about the Problem 1.2) but it is also possible to start from the geometric situation to obtain Theorem 2.2 and Corollary 2.3.

In [9] using pure combinatorially and geometric methods Marco Reni and the author prove the following theorem.

**THEOREM 2.4.** [9] *Let  $M$  be the hyperbolic 2-fold branched covering of a knot. For any (finite) 2-group  $S$  of orientation-preserving isometries of  $M$  which contains the covering involution of the knot, the singularity graph of the quotient orbifold  $M/S$  is combinatorially equivalent to one of the twelve graphs IA, ..., IIID (Figure 1).*

The number of conjugacy classes of non-free involutions in any 2-subgroup  $S$  of the isometry group of  $M$  is bounded by the number of edges of the singularity graph of  $M/S$ ; thus by Theorem 2.4 we obtain again Theorem 2.2 and Corollary 2.3.

Theorem 2.4 holds also for the case of 2-fold cyclic branched covering of links with two components, and we prove again that there are at most nine inequivalent 2-components links with the same hyperbolic 2-fold branched covering. This result for two components links is not yet proved using the algebraic approach while in the case of links with at least 3 components the Problem 1.1 was solved in [13] detecting the algebraic structure of the Sylow 2-subgroups; we have that five is the maximal number of inequivalent links with at least three components which have the same hyperbolic 2-fold branched covering.

Theorem 2.4 describes, in some sense, the geometric situation of the group  $S$  by a global point of view; a description of the “local” situation is more appropriate to give a direct answer to Problem 1.2. In [8] we describe the singularity graph of the manifold  $M/D$  where  $D$  is the group generated by two covering involutions and in this way we give a precise solution of Problem 1.2.

Before presenting the theorem we have to describe the following basic constructions which relate two knots with the same 2-fold

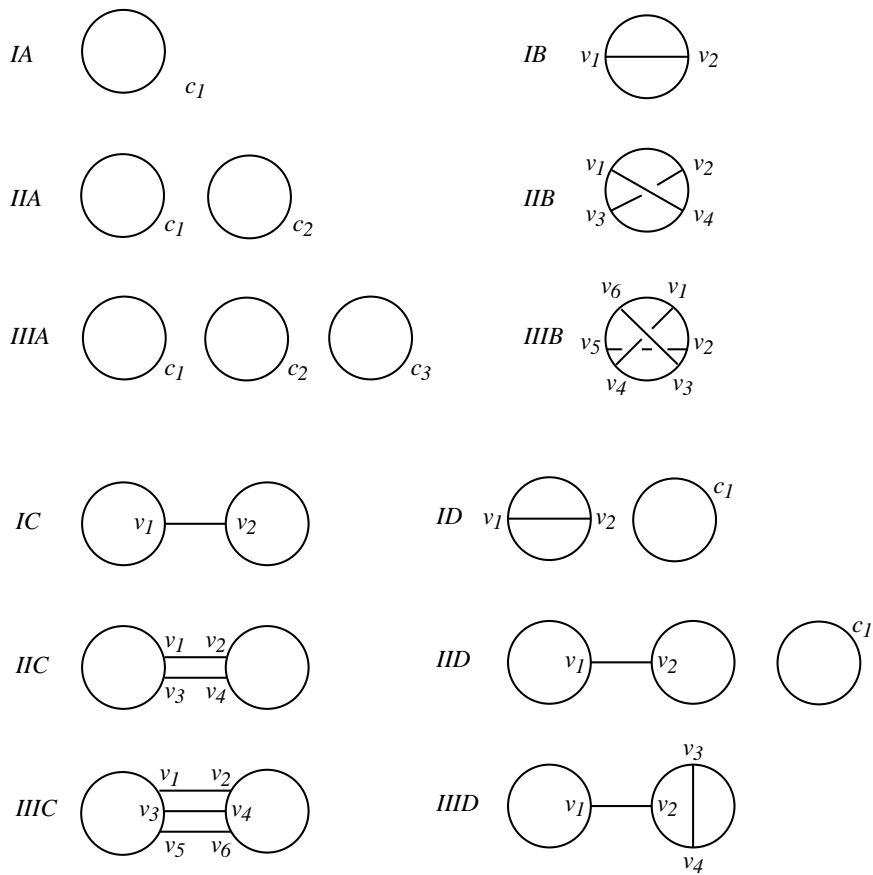

Figure 1.

branched covering. Let  $M$  be the 2-fold branched covering of two inequivalent knots  $K$  and  $K'$ . We suppose that the two covering involutions of  $K$  and  $K'$  generate a dihedral group  $D$  of order  $2^{m+1}$  and we denote by  $F$  the cyclic group of order  $2^m$  generated by the product of the two covering involutions.

**The standard dihedral construction I**

Each element of  $F$  acts freely on  $M$ . The quotient orbifold  $M/D$  is the 3-sphere whose singular set is a link with two components of singularity index two. In this case we say that  $K$  and  $K'$  arise from

the standard dihedral construction I.

### The standard dihedral construction II

The subgroup  $F$  has non-empty connected fixed-point set  $L$  (i.e. each element of  $F$  fixes pointwise  $L$ ). The reflections in  $D$  act as reflections on  $L$ . The quotient orbifold  $M/D$  is the 3-sphere whose singular set is a theta-curve (the graph IB in figure 1); two edges have singularity index two, the remaining one has singularity index  $2^m$ . In this case we say that  $K$  and  $K'$  arise from the standard dihedral construction II.

### The standard dihedral construction III

The group  $F$  has no global fixed-points but  $F$  contains a proper subgroup with non-empty fixed-point set.

We denote by  $2^q$  the order of the maximal subgroup of  $F$  with non-empty fixed-point set and we denote by  $L$  its connected fixed-point set. The reflections in  $D$  act as reflections on  $L$ . The quotient orbifold  $M/D$  is the 3-sphere whose singular set is a pince-nez graph (the graph IC in figure 1); the two loops have singularity index two, the remaining edge has singularity index  $2^q$ . In this case we say that  $K$  and  $K'$  arise from the standard dihedral construction III.

Finally we can state the following theorem that solves the Problem 1.2.

**THEOREM 2.5.** [8] *Let  $M$  be the 2-fold cyclic branched covering of the inequivalent knots  $K$  and  $K'$ . Suppose that  $M$  is hyperbolic. Then  $K$  and  $K'$  arise from the standard dihedral construction I, II or III.*

We note that the Theorem 2.5 holds also for knots in  $\mathbb{Z}_2$ -homology 3-spheres.

In the second part of the paper we present examples of knots which arise from the standard dihedral constructions and we prove that all these cases really occur.

**3. Construction of knots with the same 2-fold branched covering**

In this section we present examples of knots with the same hyperbolic 3-manifold as 2-fold branched covering; we produce at least one example for each construction described in Theorem 2.5.

There is the possibility to create knots with the same 2-fold branched covering applying Dehn surgery on a hyperbolic knot (see also [18]). By Mostow’s rigidity theorem, the symmetry group of a hyperbolic knot  $L$  can be realized by a finite group of diffeomorphism of the couple  $(S^3, L)$ , restricting to isometries of  $S^3 - L$ . By the positive solution of the Smith conjecture, this finite group acts effectively on the knot, so the symmetry group of a hyperbolic knot is a finite cyclic or dihedral group. We are interested in the dihedral case and consider knots with the following property.

PROPERTY 3.1. *The knot  $L$  is hyperbolic; the orientation-preserving symmetry group of  $L$  is a dihedral group  $D$  of order  $2n$  which is generated by two strong inversions (reflections)  $i$  and  $j$ .*

We shall see that any knot with Property 3.1, for  $n$  even, can be used to construct an example of one of the 3 standard dihedral constructions. Let  $L$  be a knot with Property 3.1 and  $M = M(L, 1/a)$  be the homology 3-sphere obtained by  $1/a$ -surgery on  $L$ . We consider sufficiently large values of  $a$  such that  $M$  is hyperbolic and the central line  $L'$  of the added solid torus is the unique shortest geodesic. Thus any element of the orientation-preserving isometry group  $G$  of  $M$  restricts to  $M - L' = S^3 - L$ . Since by Gordon and Luecke’s theorem a nontrivial surgery on a nontrivial knot never yields  $S^3$ , each diffeomorphism of  $S^3 - L$  maps a meridian to a meridian and it can be extended to a symmetry of  $L$ .

In this way the elements of  $G$  can be first restricted to  $S^3 - L$  and then extended to a symmetry of  $L$  and we obtain a subgroup of  $D$  isomorphic to  $G$ . On the other hand any element of  $D$  can be restricted to  $S^3 - L$  and since it maps a meridian to a meridian it can be extended to a diffeomorphism of  $M$ . We obtain a group of diffeomorphism of  $M$  isomorphic to  $D$  which, by Thurston’s orbifold geometrization theorem, is conjugate to a subgroup of  $G$ . Thus we

have an isomorphism between  $G$  and  $D$ ; we denote any element of  $G$  with the same letter as the corresponding element in  $D$ .

Now we consider the quotient orbifold  $M/i$ . The quotient of  $M$  by the strong inversion  $i$  is obtained by surgery on a 3-ball in  $S^3$  (the quotient by  $i$  of a regular neighbourhood of  $L$ ) and it is an orbifold with underlying topological space the 3-sphere. The same argument holds for the quotient orbifold  $M/j$ . We denote by  $K$  the projection of the fixed-point set of  $i$  in the quotient  $M/i$  and by  $K'$  the projection of the fixed-point set of  $j$  in the quotient  $M/j$ .

If  $n$  is odd the two involutions  $i$  and  $j$  are conjugate and the knots  $K$  and  $K'$  are equivalent. Since we are looking for inequivalent knots, we suppose that  $n$  is even. In this case  $K$  and  $K'$  are inequivalent (otherwise an isometry of  $M$  conjugates  $i$  and  $j$  by Mostow's rigidity Theorem).

We restrict our attention to a Sylow 2-subgroup  $S$  of  $G$  which contains  $i$ ;  $S$  is a dihedral group of order  $2^{m+1}$ . In  $S$  there exists an involution  $j'$  conjugate to  $j$  and the quotient orbifold  $M/j'$  is equivalent to  $M/j$  (in particular the singular sets of the orbifolds are equivalent knots). We consider  $K'$  as the projection of the fixed-point set of  $j'$  in the quotient  $M/j' \cong S^3$ . Now we consider  $F$ , the cyclic subgroup of  $S$  of order  $2^m$  and we have three cases.

- i) If  $F$  acts freely,  $K$  and  $K'$  arise from the standard dihedral construction I.
- ii) If  $F$  has non-empty fixed-point set, then  $K$  and  $K'$  arise from the standard dihedral construction II.
- iii) If  $F$  has no global fixed-point set but it contains a proper subgroup  $E$  with non-empty fixed-point set, then  $K$  and  $K'$  arise from the standard dihedral construction III.

For the case ii) we can obtain a nice class of examples generated starting from the following class of links.

We denote by  $T_n$  the closure of the 3-braid  $(\sigma_1^{-1}\sigma_2)^n$  ( $T_8$  is represented Figure 2); the links  $T_n$  are called the Turk's head links. For  $n \geq 5$  these links are hyperbolic and  $D$ , the orientation-preserving symmetry group of  $T_n$ , is a dihedral group of order  $n$  ([SW]). We note that the maximal cyclic subgroup in  $D$  has non-empty fixed-point set



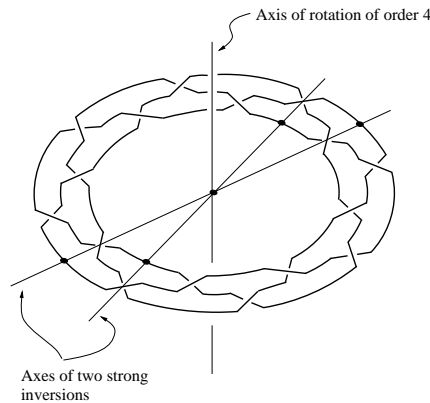

Figure 2.

because this group can be represented as a group of rotation around an axis in the 3-sphere (see Figure 2). In this case the fixed-point sets of any two strong inversions in  $D$  intersect in two points of the axis of the maximal cyclic subgroup of  $D$  (in Figure 2 only one point, marked with a black point, appears, the other intersection point is at infinity). In fact the product of any two strong inversions has non-empty fixed-point set.

Finally we have that for  $n \not\equiv 0 \pmod 3$   $T_n$  is a knot.

The knots  $T_{2^m}$  with  $m \geq 3$  satisfy the Property 3.1; by the previous consideration for each  $m \geq 3$  we can obtain two knots arising from the standard dihedral construction II such that the group of isometries generated by their covering involution has order  $2^m$ .

To obtain examples for the other two cases it is possible to use the list in ([KS]) of the symmetry groups of the knots up to ten crossing. We recall the following definitions.

- A knot has a period of order  $p$  if there is a cyclic group  $I$  of order  $p$  whose elements are orientation-preserving symmetries of the knot with fixed-point set (may be empty) disjoint from the knot.
- A knot has a cyclic period of order  $q$  if there is a cyclic group  $I$  of order  $q$  whose elements are orientation-preserving symme-

tries with non-empty fixed-point set disjoint from the knot.

For example we can consider the knot  $10_{157}$  that has a dihedral group of symmetries of order eight but it has no cyclic period. This knot is the closure of the 3-braid  $(\sigma_1^{-1}\sigma_2)^4\Delta^2$  (see [4]);  $\Delta$  is the 3-braid  $\sigma_1\sigma_2\sigma_1$  and we remember that  $\Delta^2$  is a generator of the center of 3-braid group. By a geometric point of view we can imagine to draw the 3-braid  $(\sigma_1^{-1}\sigma_2)^4$  in a strip of paper and then to join the two ends with a full twist;  $\Delta^2$  is the full twist. In the Figure 3  $10_{157}$  is presented in the three dimensional space in this form; a system of cartesian axes is presented in the figure and the crossings "lie" in some different planes because we must rotate the strip of paper. (We can think that the crossings  $C_1$  and  $C_5$  lie in the  $xy$ -plane, the crossings  $C_3$  and  $C_7$  lie in two plains which are parallel to the  $zy$ -plane,  $(-1, -1, 1)$  is a normal vector to the plane where the crossing  $C_2$  lies,  $(-1, 1, -1)$  is the normal vector for  $C_4$ ,  $(1, 1, 1)$  for  $C_6$  and finally  $(1, -1, 1)$  for  $C_8$ .)

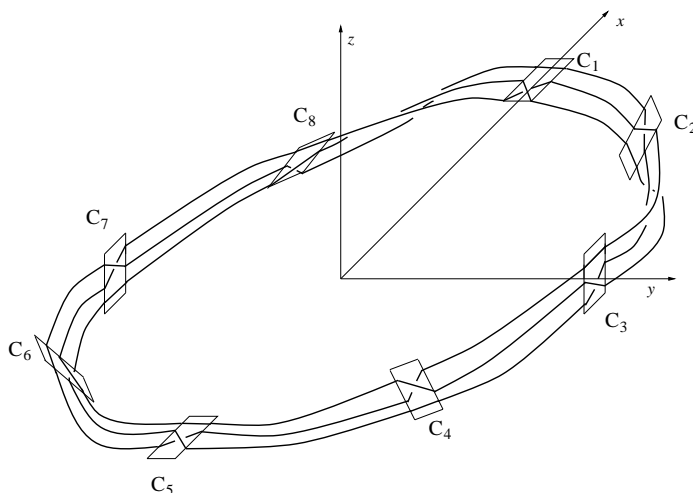

Figure 3.

A generator of the cyclic group of symmetries of order four is the product of a rotation of order four around the axis  $\tau$  and a rotation of order four around the axis  $\mu$  (see Figure 4).

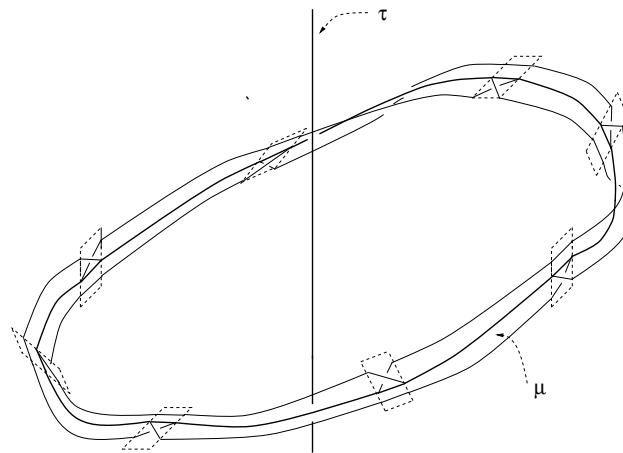

Figure 4.

We note that in this case the fixed-point sets of the strong inversions are pairwise disjoint (see Figure 5), in fact the product of any two strong inversions is a symmetry acting freely.

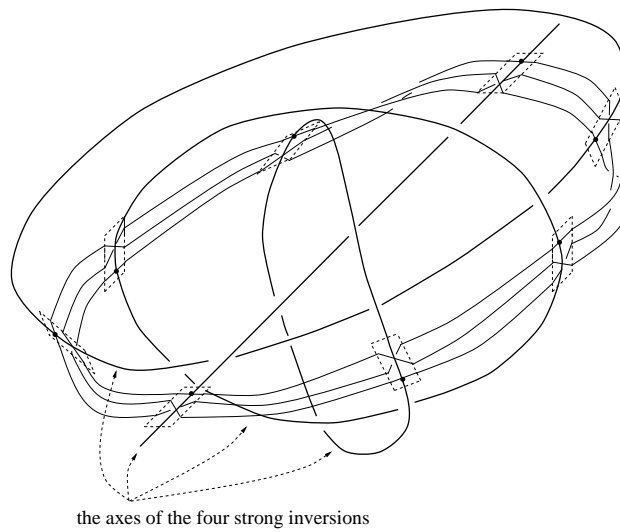

Figure 5.

An example for the standard construction III can be obtained from the knot  $7_4$ ; by the list in [6] we know that  $D$ , the group of symmetries of the knots  $7_4$ , is a dihedral group of order eight with a period of order four and a cyclic period of order two and we can obtain two inequivalent knots which arise from the standard dihedral construction III. The knot  $7_4$  is a 2-bridge knot, and exactly the knot  $15/4$  (see the first picture in in Figure 6). It is possible to have a projection of  $15/4$  as represented in the second picture of Figure 6 (see [11]); to visualize the symmetries we draw the knot on the 2-sphere (third picture in figure 6). The cyclic period is given by a

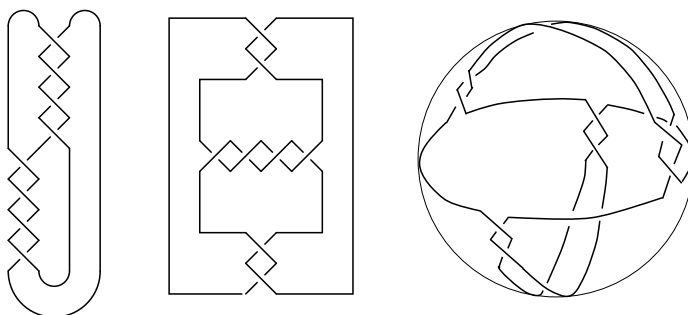

Figure 6.

rotation of order two around the axis  $\tau$ , the symmetry of order 4 is the product of a rotation of order four around the axis  $\tau$  and a rotation of order 2 around the axis  $\mu$  (see the first picture in Figure 7). In the second picture in Figure 7 we draw the fixed-point sets of the four strong inversions and we mark the intersections between the knot and the axes of the strong inversions (points  $q_i$   $i = 1, \dots, 8$ ) and between the different fixed-point sets of the strong inversions (points  $p_i$   $i = 1, \dots, 3$  and one point at infinity). In this case we note that the fixed-point sets of two strong inversions that generate  $D$  are disjoint, in fact the product of two strong inversions of this type is a symmetry acting freely; on the other hand the fixed-point sets of two strong inversions such that their product is the central involution in  $D$  (that has non-empty fixed-point set) intersect in two points of the axis  $\tau$ .

To obtain other examples of inequivalent knots which arise from

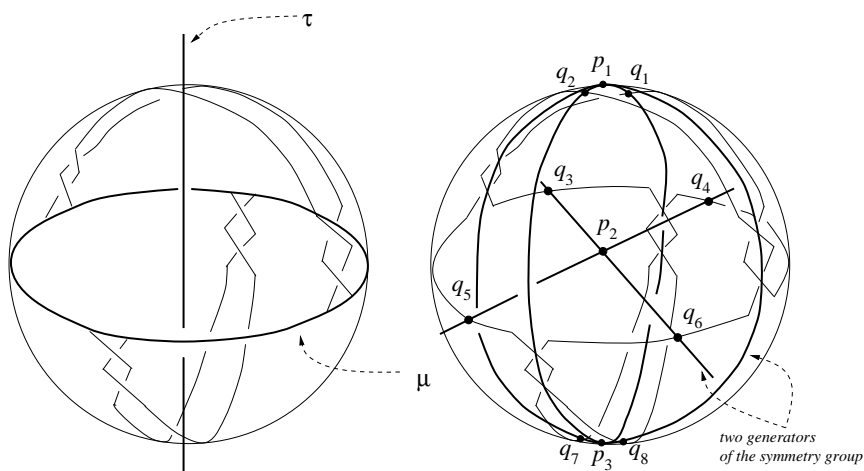

Figure 7.

standard dihedral construction III, we can use Montesinos knots. The hyperbolicity of Montesinos links and its symmetry groups are known (see [2]); there exist Montesinos knots with dihedral symmetry group of order  $2^{m+1}$ , period of order  $2^m$  and cyclic period of order 2. We note that any Montesinos knot has a cyclic period of order 2 and has no cyclic period of order  $2^m$  with  $m > 1$ , thus also in this case we can not find more general classes of examples.

In general it is easy to find knots with any period and cyclic period but it is not trivial to investigate the hyperbolicity of these knots.

For example generalizing the construction presented for the knot  $10_{157}$  we consider the closures  $T_{(m,k)}$  of the 3-braids  $(\sigma_1^{-1}\sigma_2)^{2^m}\Delta^{2k}$ . We note that for  $k = 0$  we obtain Turk's head knots.

The knot  $T_{(m,k)}$  has a period of order  $2^m$  and a cyclic period of order the maximal common divisor between  $2^m$  and  $k$  (see also [4]). A general proof of the hyperbolicity of these knots (if they are hyperbolic) and the study of the symmetry groups are non-trivial.

We check the knots  $T_{(8,1)}$ ,  $T_{(8,2)}$ ,  $T_{(8,4)}$  by J.Week's program Snap-Pea and we have other examples of standard dihedral construction I and III where the group generated by the covering involutions is a

dihedral group of order 16.

Other examples can be obtained by the Wolcott theta curve introduced in [17].

The Wolcott theta curve  $\Theta_{a,b,c}$  is presented in Figure 8 where  $a, b, c$  represent the numbers of full twists in the dashed circles .

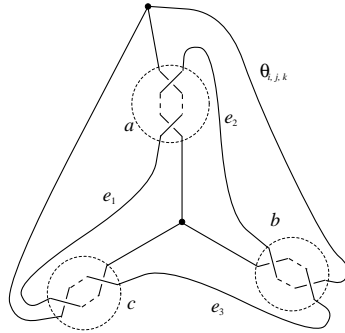

Figure 8.

First we know that for  $a, b$  and  $c$  different each other and sufficiently large, the  $\mathbb{Z}_2 \times \mathbb{Z}_2$  branched covering of  $\Theta_{a,b,c}$  is a hyperbolic 3-manifold  $M_{a,b,c}$  with orientation-preserving isometry group  $G$  isomorphic to  $\mathbb{Z}_2 \times \mathbb{Z}_2$  (see [18] and [10]). We denote by  $t_1, t_2$  and  $t_3$  the three involutions in  $G$ , we know that the quotient orbifolds  $M/t_i$  have the 3-sphere as underlying topological space. The singular sets of  $M/t_i$  are inequivalent knots (otherwise the covering involutions are conjugate in  $G$ ) and any two of them arise from the dihedral construction II.

We consider now the case with  $a = b \neq c$ ; for  $a, c$  sufficiently large and not in the form  $\{lm, (l-1)m\}$  with  $l$  and  $m$  integers and  $l$  even, we know that the  $\mathbb{Z}_2 \times \mathbb{Z}_2$  branched covering of  $\Theta_{a,b,c}$  is an hyperbolic 3-manifold  $M_{a,b,c}$  with orientation-preserving isometry group  $G$  isomorphic to the dihedral group of order eight (see [10]). The quotient orbifold  $M_{a,b,c}/G$  is a 3-sphere with singular set a pincenez graph. Let  $t_1$  and  $t_2$  a couple of involutions which generate  $G$ , it is possible to prove (drawing the singular set of the various quotient orbifolds) that the two quotient orbifolds  $M/t_1$  and  $M/t_2$  have the

3-sphere as underlying topological space. The singular set of  $M/t_1$  and  $M/t_2$  are inequivalent knots (otherwise  $t_1$  and  $t_2$  are conjugate in  $G$ ) and they arise from the standard dihedral construction III.

These examples prove that all the situations described in Theorem 2.5 really occur.

### Acknowledgments

I want to thank Bruno Zimmermann for his useful advices.

### REFERENCES

- [1] M. BOIELAU AND J. PORTI, *Geometrization of 3-orbifolds of cyclic type*, Prépublication, 1998.
- [2] M. BOIELAU AND B. ZIMMERMANN, *Symmetries of nonelliptic montesinos links*, Math. Ann. **277** (2000), 563–584.
- [3] D. COOPE, C.D. HODGSON, AND S.P. KERCKHOFF, *Three-dimensional orbifolds and cone manifolds*, Math. Soc. Japan Memoirs, vol. 5, 2000.
- [4] R. HARTLEY, *Knots with free period*, Can. J. Math. (1981), no. 33, 91–102.
- [5] R. KIRBY, *Problems in low-dimensional topology. geometric topology*, Studies in Advanced Mathematics, vol. 2, part 2, International Press, University of Georgia, 1997.
- [6] K. KODAMA AND M. SAKUMA, *Symmetry groups of prime knots up to 10 crossing*, Knots, vol. 90, Walter de Gruyter & Co., Berlin–New York, 1992.
- [7] C. MCA.GORDON, *Some aspects of classical knot theory*, Knot Theory, Proc. Plans-sur-Bex, Switzerland (J.C. Hausmann, ed.), Lect. Notes Math., vol. 685, Springer, 1977, pp. 1–60.
- [8] M. MECCHIA, *How hyperbolic knots with homeomorphic cyclic branched coverings are related*, to appear in Topology Appl.
- [9] M. MECCHIA AND M. RENI, *Hyperbolic 2-fold branched coverings of links and their quotients*, to appear in Pacific J. Math.
- [10] M. MECCHIA AND M. RENI, *Hyperbolic 2-fold branched covering of 3-bridge knots*, Kobe J. Math. **17** (2000), 1–19.
- [11] M. MECCHIA AND B. ZIMMERMANN, *On a class of hyperbolic 3-orbifolds of small volume and small Heegard genus associated to 2-bridge links*, Rend. Circ. Mat. Palermo **49** (2000), 41–60.
- [12] M. RENI, *On  $\pi$ -hyperbolic knots with the same 2-fold branched covering*, Math. Ann. **316** (2000), 681–697.

- [13] M. RENI AND B. ZIMMERMANN, *On hyperelliptic involutions of hyperbolic 3-manifolds*, to appear in Math. Ann.
- [14] M. SAKUMA AND J. WEEKS, *Examples of canonical decompositions of hyperbolic link complements*, Japan J. of Math. **21** (1995), 393–439.
- [15] W. THURSTON, *The geometry and topology of 3-manifolds*, Lecture Notes, Princeton University, 1978.
- [16] W. THURSTON, *3-manifolds with symmetry*, Preprint, 1982.
- [17] K. WOLCOTT, *The knotting of theta-curves and other graphs in  $S^3$* , Ph.D. thesis, University of Iowa, 1985.
- [18] B. ZIMMERMANN, *On hyperbolic knots with the same  $m$ -fold and  $n$ -fold cyclic branched coverings*, Topology Appl. **79** (1997), 143–157.

Received April 24, 2001.